

PINCH

Pinch

Family

Armchair / Sofa

Designer

Skrivo Design / 2016

Link

www.read-mo.re/pinch



PRODUCT SHEET

PINCH

Dati tecnici · Technical data · Données techniques · Technische Angaben

Varianti · Variants · Variantes · Varianten

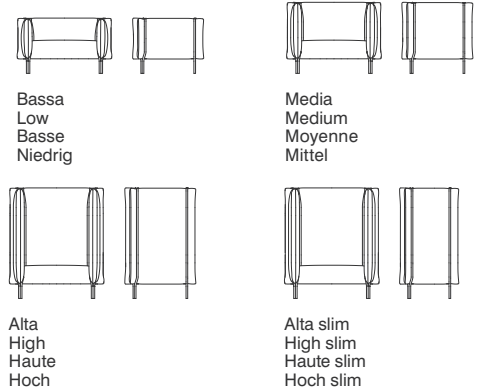
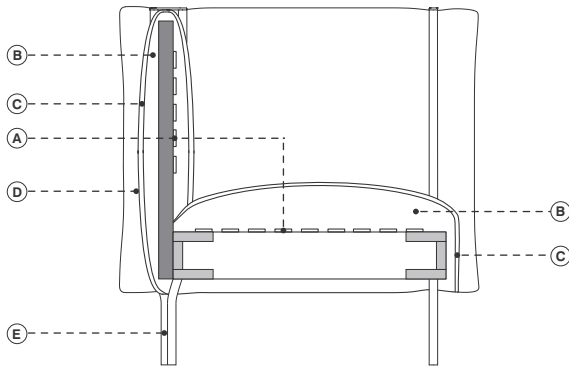

- Legno massiccio di faggio
- Multistrato di faggio
- A. Cinghie elastiche ad alta densità
- B. Poliuretano espanso ignifugo indeformabile a quote differenziate
- C. Fibra di poliestere
- D. Rivestimento fisso in tessuto o pelle
- E. Acciaio

- Solid beech
- Multilayered beech
- A. High density elastic straps
- B. Flame-retardant undeformable polyurethane foam of different densities
- C. Polyester fibers
- D. Fixed upholstery in fabric or leather
- E. Steel

- Bois de hêtre massif
- Multiplis de hêtre
- A. Sangles élastiques
- B. Mousse polyuréthane expansé ignifuge indéformable à épaisseurs différenciées
- C. Fibre de polyester
- D. Revêtement pas déhoussable en tissu ou cuir
- E. Acier

- Massivholz aus Buche
- Buchenschichtholz
- A. Elastischen Gurtbändern
- B. Feuerfester formbeständige Polyurethanschaum in unterschiedlicher Dichte
- C. Polyester
- D. Unabziehbarer Bezug aus Stoff oder Leder
- E. Stahl

Note · Notes · Annotation · Anmerkung

- Base personalizzabile con tinta cliente
- Cuscini extra disponibili
- COM: tessuto cliente (tinta unita e h.140 cm.) - campione richiesto
- COL: pelle cliente - campione richiesto
- CAT. SPECIAL: prezzo e disponibilità su richiesta

- Base customizable with customer's colors on request
- Extra cushions available
- COM: client's fabric (plain colour and width 140 cm.) - sample required
- COL: client's leather - sample required
- CAT. SPECIAL: price and availability on request

- Piètement personnalisable avec coloris du sur demande
- Autres coussins disponibles
- COM: tissu fourni (couleur unie et hauteur 140 cm.) - échantillon nécessaire
- COL: cuir fourni - échantillon nécessaire
- CAT. SPECIAL: prix et disponibilité sur demande

- Gestell in Kundenfarben auf Anfrage verfügbar
- Weitere Kissen verfügbar
- COM: Kundenstoff (einfarbig und Breite 140 cm.) - Stoffmuster nötig
- COL: Kundenleder - Ledermuster nötig
- CAT. SPECIAL: Preis und Verfügbarkeit auf Anfrage

Finiture · Finishes · Finitions · Ausführungen



Avorio
Ivory
Ivoire
Elfenbein



Prugna
Plum
Prune
Pflaume



Nero pece
Pitch black
Poix noir
Pech Schwarz

Opzione · Option · Option · Opzjon



Su richiesta attacco per connessione elettrica e USB con sovrapprezzo
Electrical connection and USB upon request with upcharge
Sur demande connection électrique et USB avec surcoût
Elektrische Verbindung und USB-Anschluss auf Anfrage gegen Aufpreis

Rivestimenti consigliati · Recommended coverings · Revêtements conseillées · Empfohlene Bezüge

| | | | | | | | |
|----------|----------------|--------------|---------------|--------------|-----------------|-----------------|------------|
| • cat. A | XTREME | • cat. C | TREND | • cat. extra | MOLLY | • cat. lux | LUX 1 |
| • cat. A | STEP | • cat. C | SUPERB | • cat. extra | RIME | • cat. lux | LUX 2 |
| • cat. A | ANGEL | • cat. C | UMAMI | • cat. extra | STEELCUT TRIO 3 | • cat. imperial | IMPERIAL 1 |
| • cat. A | MEDLEY | • cat. C | HESTAN | • cat. extra | ARIANA | • cat. imperial | IMPERIAL 2 |
| • cat. A | MOOD | • cat. C | DEANS | • cat. extra | COLLINE | • cat. imperial | NABUK |
| • cat. A | CRAZY | • cat. super | REMIX 2 | • cat. extra | OPERA | • cat. special | BEANS |
| • cat. B | EXTREMA | • cat. super | CAPTURE | • cat. extra | DANTE | • cat. special | DROP |
| • cat. B | IKON | • cat. super | MODA | • cat. extra | ARCO | • cat. special | MOSAIC |
| • cat. B | SILVERTEX | • cat. super | REVIVE 1 | • cat. maxi | HALLINGDAL 65 | • cat. special | TRIANGLE |
| • cat. B | SAMAR | • cat. super | BREEZE FUSION | • cat. maxi | COMFORT | | |
| • cat. B | FAME | | | • cat. maxi | DIVINA 3 | | |
| • cat. B | MAIN LINE FLAX | | | | | | |

PINCH

cod. 9080 / armchair H 70

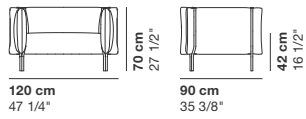

cod. 9081 / 2 seater H 70

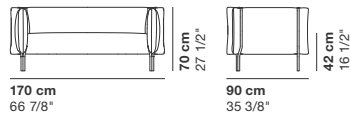

cod. 9082 / 3 seater H 70

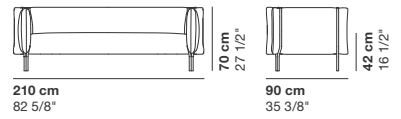

cod. 9083 / 3 seater major H 70

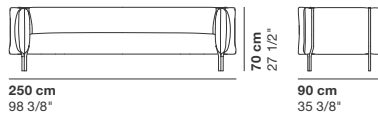

cod. 9084 / armchair H 90

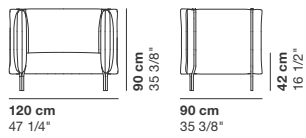

cod. 9085 / 2 seater H 90

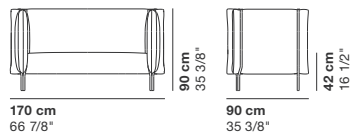

cod. 9086 / 3 seater H 90

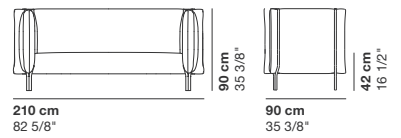

cod. 9087 / 3 seater major H 90

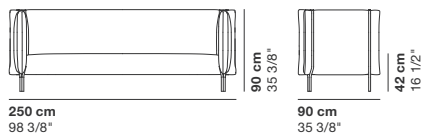

cod. 9088 / armchair H 140

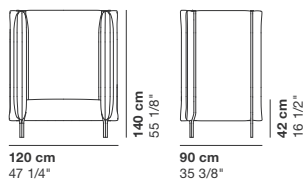

cod. 9089 / 2 seater H 140

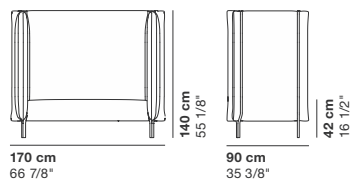

cod. 9090 / 3 seater H 140

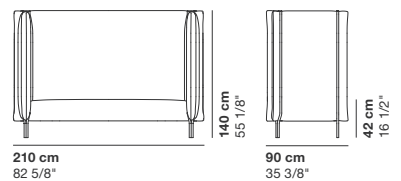

cod. 9091 / 3 seater major H 140

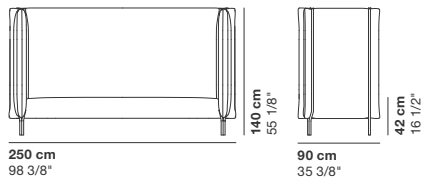

PINCH

cod. 9100 / slim_armchair H 140

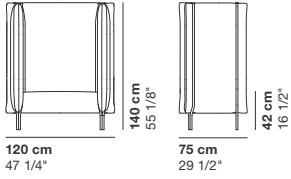

cod. 9101 / slim_2 seater H 140

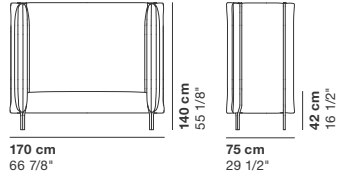

cod. 9102 / slim_3 seater H 140

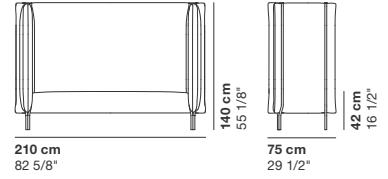

cod. 9103 / slim_3 seater major H 140

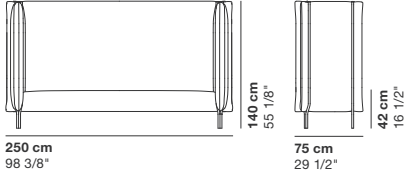

cod. 9104 / partition panel

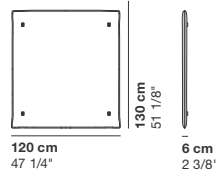

cod. 9092 / additional right table

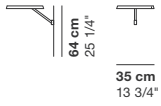

cod. 9093 / additional left table

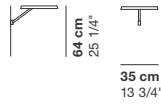

cod. 10020 / cushion

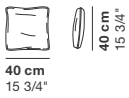

cod. 10021 / cushion

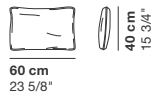

cod. 10022 / cushion

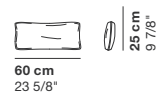

cod. 10023 / cushion

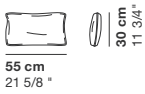

cod. 10024 / cushion

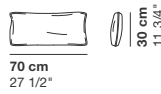

La Cividina s.r.l., al fine di migliorare caratteristiche tecniche e qualitative della sua produzione, si riserva di apportare, anche senza preavviso, tutte le modifiche che si rendessero necessarie.

With a view to improving the technical characteristics and quality of its products. La Cividina s.r.l. reserves the right to develop its products at anytime without notice.

Afin d'améliorer les caractéristiques techniques et qualitatives de sa production, La Cividina s.r.l. se réserve d'apporter, même sans préavis, toutes les modifications qui se rendront nécessaires.

Zur Verbesserung der technischen und qualitativen Merkmale, behält sich La Cividina s.r.l. vor, alle notwendig erscheinenden Produktionsänderungen, auch ohne Vorankündigung durchzuführen.



ISO 9001



ACCREDIA



FSC



CATAS



MADE IN ITALY

LaCividina srl

**HEADQUARTERS
/ PRODUCTION**

Via Cividina 176
33035 Martignacco
Udine Italy

SHOWROOM

Via Lungolavia 1
33035 Martignacco
Udine Italy

T. + 39 0432 677433

F. + 39 0432 677480

info@lacividina.com

www.lacividina.com

VAT nr. IT01810870301